

1066

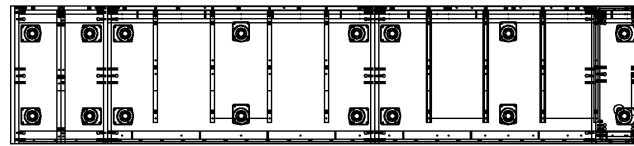

Draufsicht

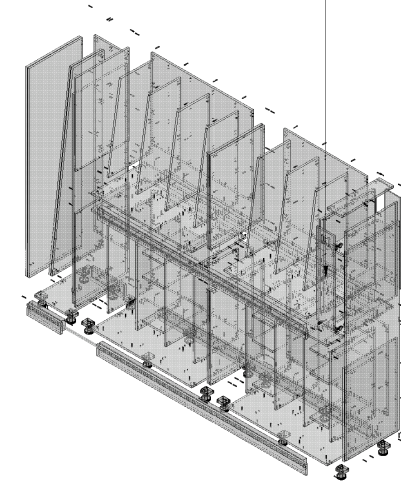

Explosionszeichnung

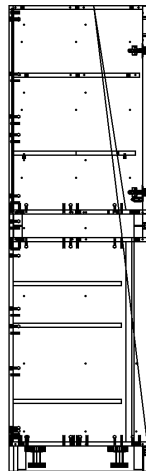

Seitenansicht links

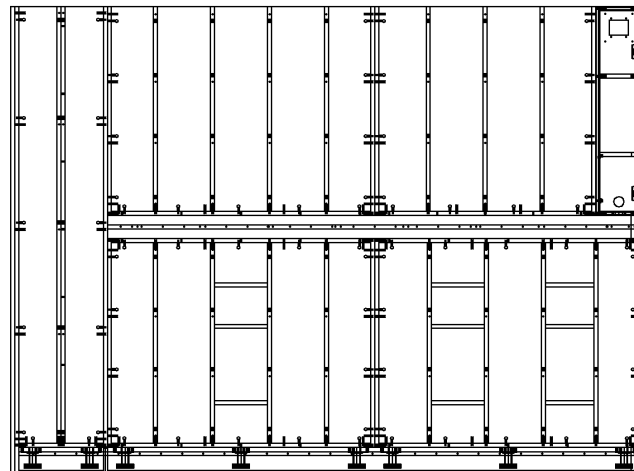

Frontansicht

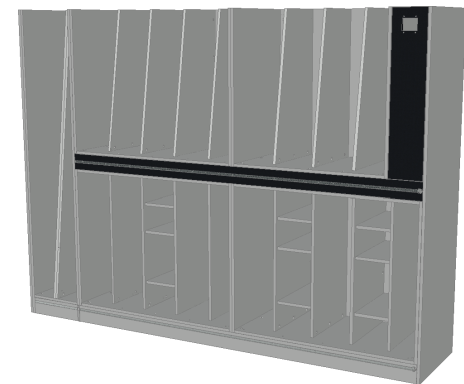

Ansicht

1.0 Übersichtszeichnung Sortierregal

Artikelinfo Artikelinfo 1 <b>Homag Digital Factory</b> Artikelinfo 2 <b>Smart Rack</b> Artikelinfo 3 <b>wCC Data</b> Artikelinfo 4 <b>Powered by Homag CSW</b> Artikelinfo 5 <b>Version wCC 2018</b>	Artikelinfo 6	Dimensionen / Weight / Position Article Height: <b>2200</b> Article Width: <b>2999</b> Article Depth: <b>650</b> Article Weight: <b>482.794</b> Hierarchy Number: <b>001</b>	Ordercolor 1	Address 1 Address 2 Address 3 Zip Notice	Date Current: <b>3/20/2020</b> Modified: <b>3/19/2020</b> Created: <b>2/3/2020</b> Loading Delivery	Article Name <b>SortingSolutionBasic</b> Article Description <b>Smart Rack</b> Construction <b>STANDARD</b>	Page <b>1</b>
	Artikelinfo 7		Ordercolor 2		Name <b>Homag CSW</b>		
	Artikelinfo 8		Ordercolor 3		Scale <b>1:25</b>		
	Artikelinfo 9		Ordercolor 4		© All		
	Artikelinfo 10		Ordercolor 5		© All		

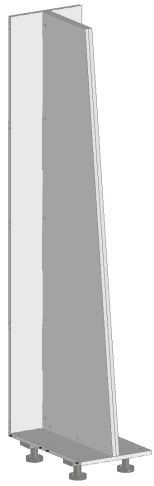

Ansicht

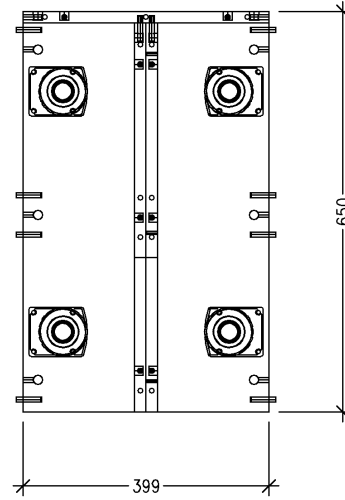

Draufsicht

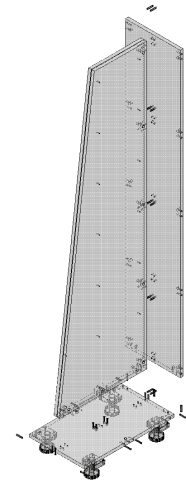

Explosionszeichnung

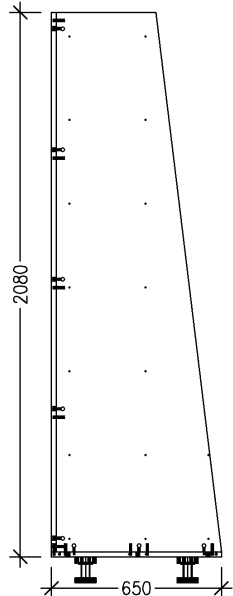

Seitenansicht links

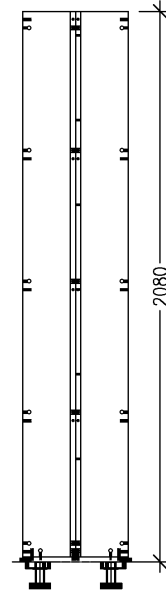

Frontansicht

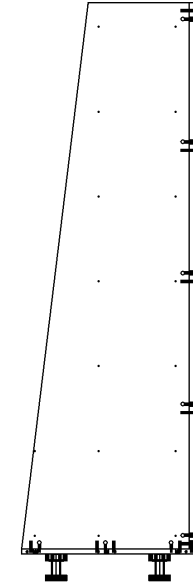

Seitenansicht rechts

1.1 Korpus für lange Bauteile Mittelseiten

<p>Long part divider</p>	Ordercolor 1	Address 1	Date	Articlename	Page
	Ordercolor 2	Address 2	Current 3/20/2020	49159	1
	Ordercolor 3	Address 3	Modified 3/19/2020	Articledescription	Name
	Ordercolor 4	Zip	Created 2/3/2020	Construction	Homag CSW
	Ordercolor 5	Notice	Delivery	STANDARD	Scale
<p>HOMAG</p>			<p>SortingSolutionBasic19_2020</p>		<p>1:25,3</p>

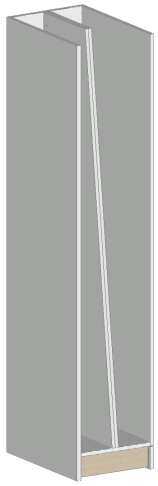

Ansicht

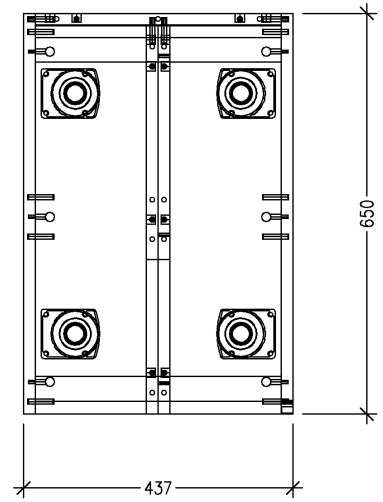

Draufsicht

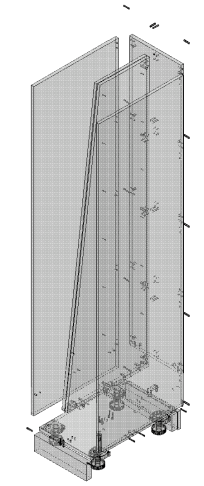

Explosionszeichnung

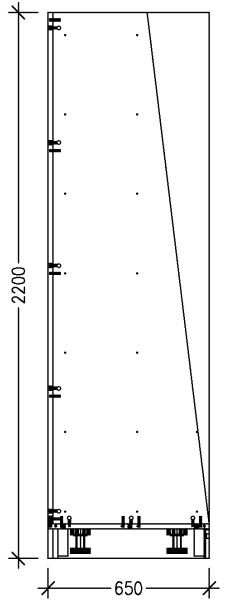

Seitenansicht links

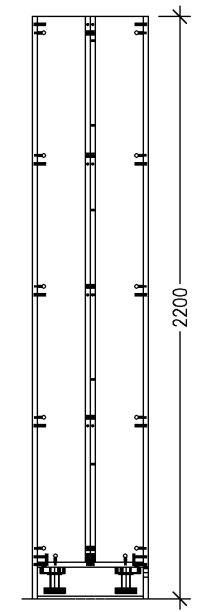

Frontansicht

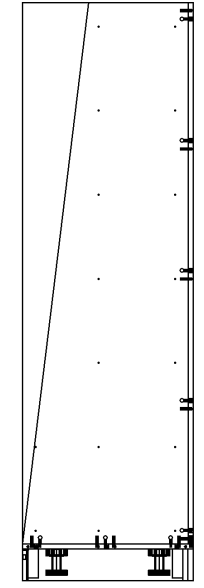

Seitenansicht rechts

1.1 Korpus für lange Bauteile

Long parts

Ordercolor 1
Ordercolor 2
Ordercolor 3
Ordercolor 4
Ordercolor 5

Address 1
Address 2
Address 3
Zip
Notice

Date
Current 3/20/2020
Modified 3/19/2020
Created 2/3/2020
Loading
Delivery

Articlename
49159
Articledescription
Construction
STANDARD

Page 1
Name Homag CSW
Scale 1:25,8
of 10

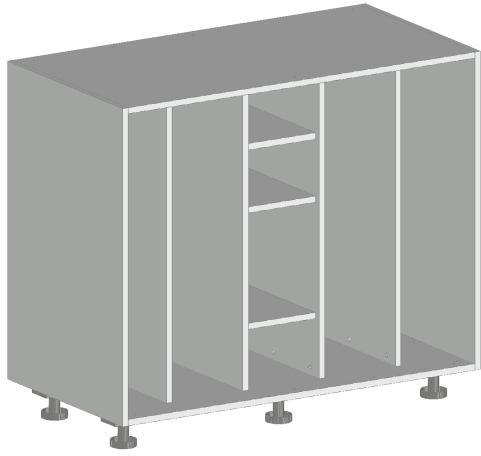

Ansicht

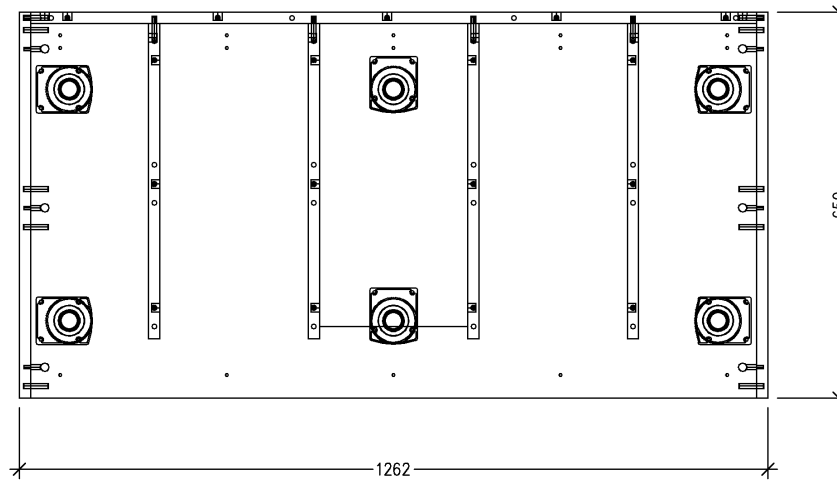

Draufsicht

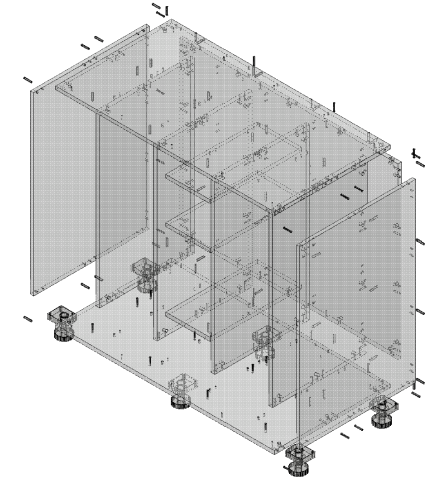

Explosionszeichnung

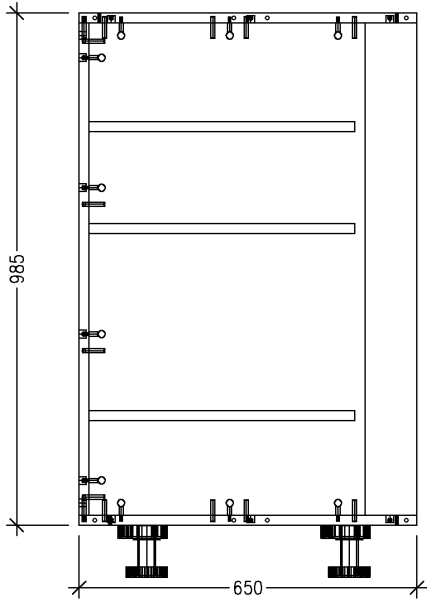

Seitenansicht links

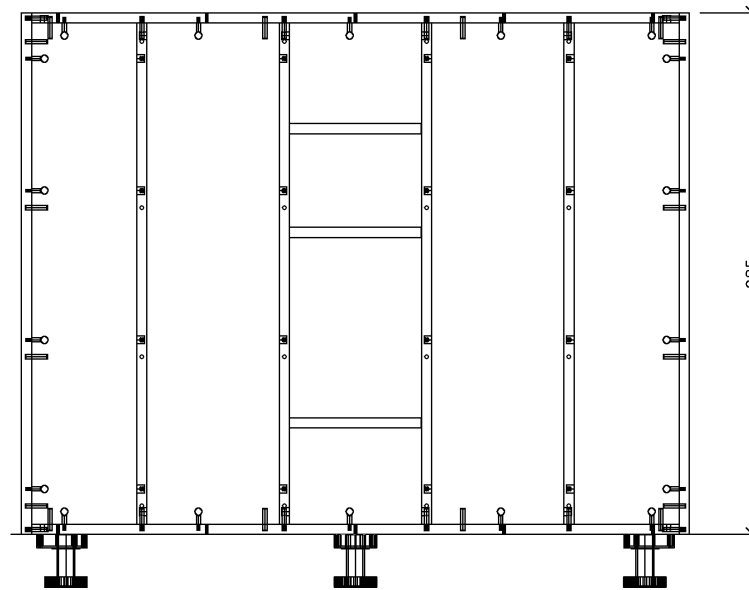

Frontansicht

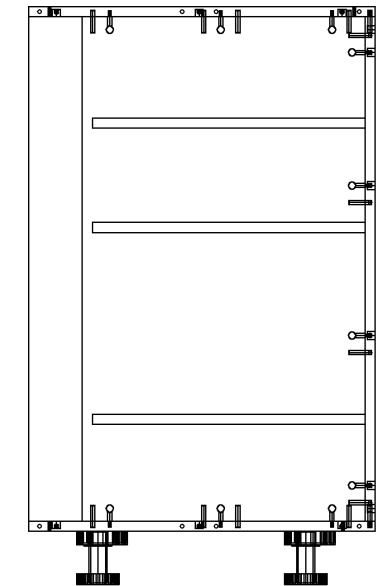

Seitenansicht rechts

1.2 Korpus unten links

Lower left

Ordercolor 1
Ordercolor 2
Ordercolor 3
Ordercolor 4
Ordercolor 5

Address 1
Address 2
Address 3
Zip
Notice

Date	Article name
Current 3/20/2020	49176
Modified 3/19/2020	Article description
Created 2/3/2020	
Loading	Construction
Delivery	STANDARD

**HOMAG** SortingSolutionBasic19\_2020

1	Page
Name	
Homag	CSW
Scale	
1:15,8	
of 10	

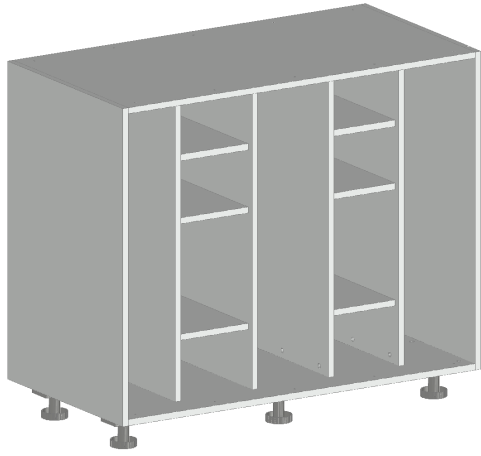

Ansicht

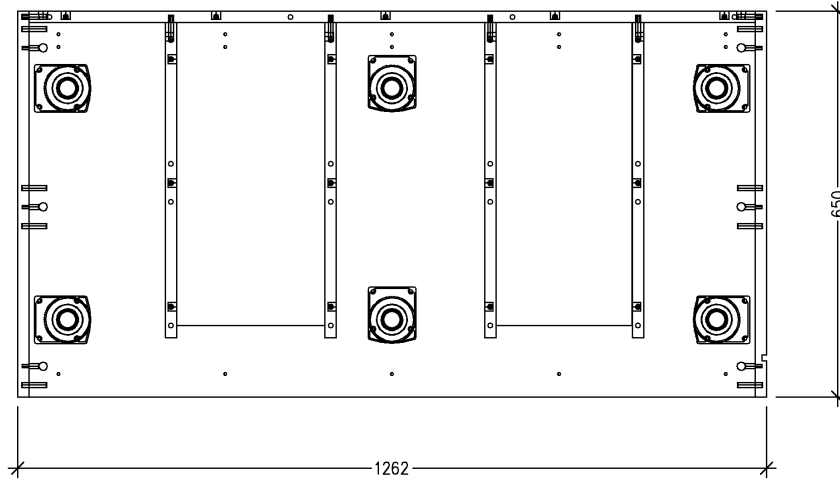

Draufsicht

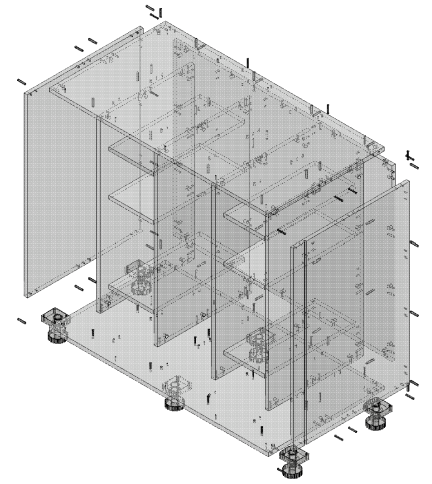

Explosionszeichnung

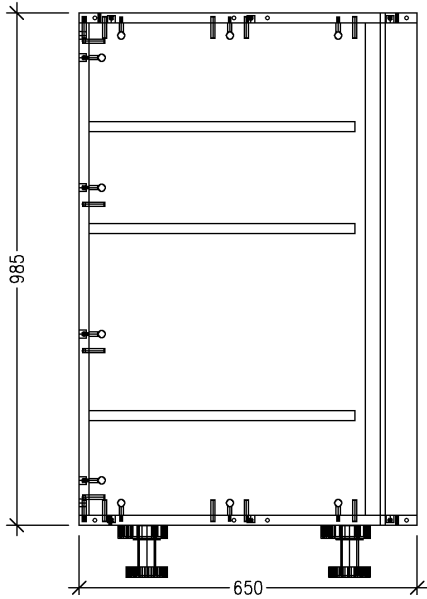

Seitenansicht links

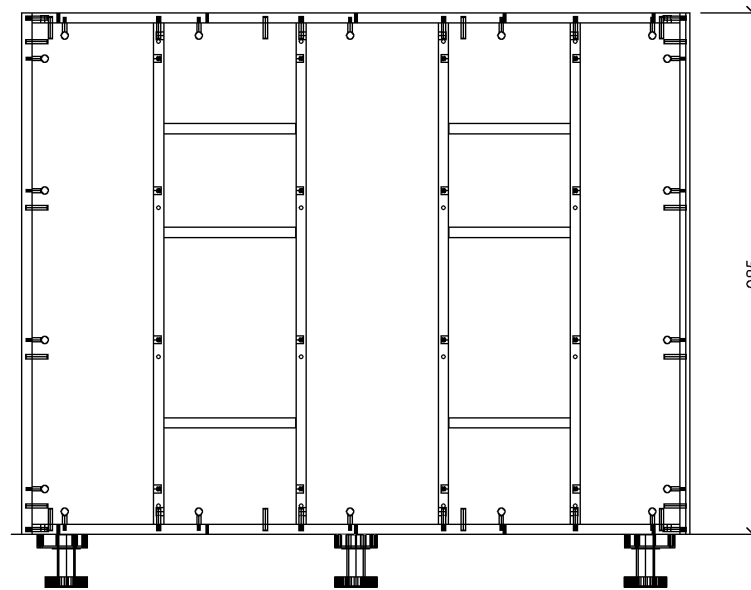

Frontansicht

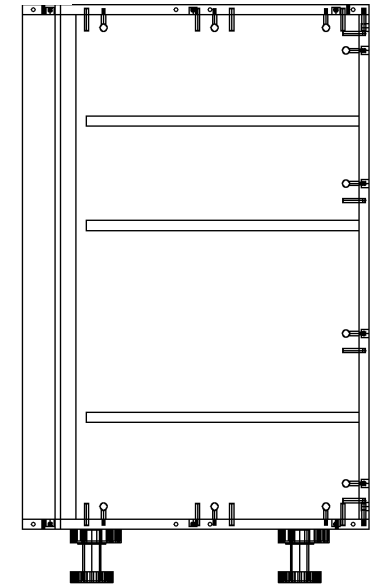

Seitenansicht rechts

1.3 Korpus unten rechts

Lower right

Ordercolor 1	Address 1	Date	Article name	1	Page
	Address 2	Current	49176	Name	
	Address 3	Modified	Article description	Homag	CSW
	Zip	Created	Construction	Scale	
	Notice	Loaded	STANDARD	1:15,8	
Ordercolor 2		Delivery			
Ordercolor 3					
Ordercolor 4		SortingSolutionBasic19_2020			
Ordercolor 5					

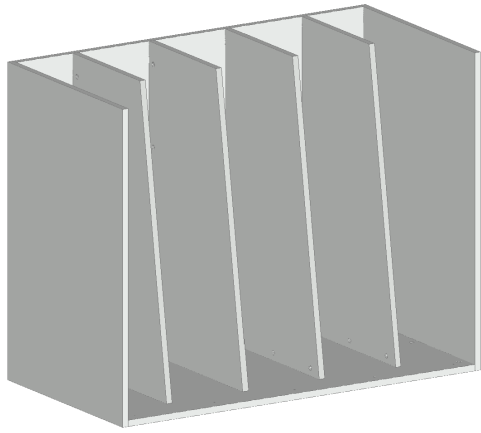

Ansicht

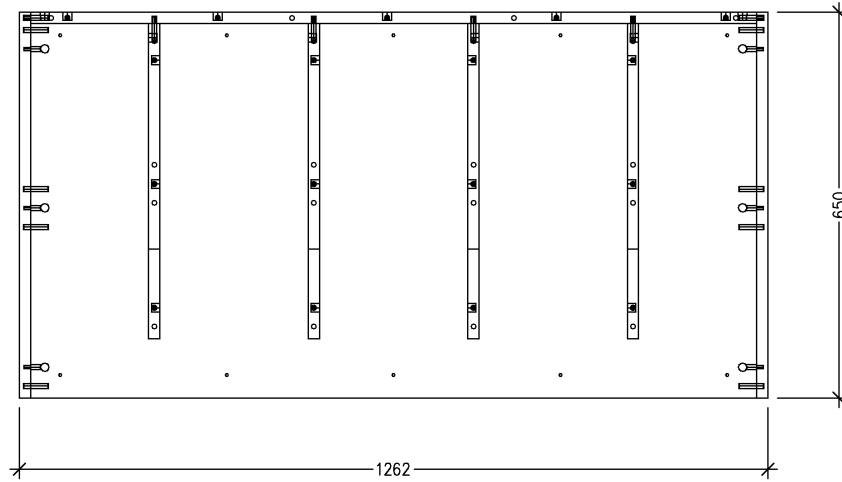

Draufsicht

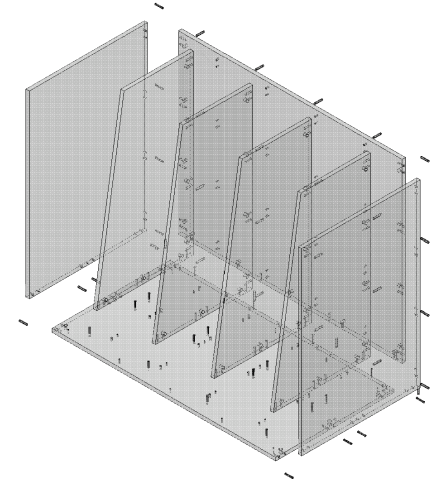

Explosionszeichnung

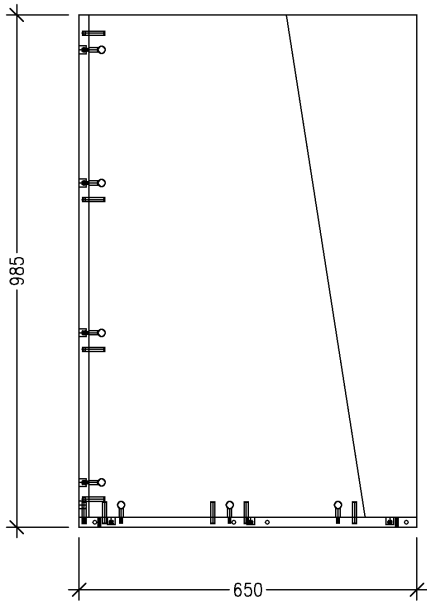

Seitenansicht links

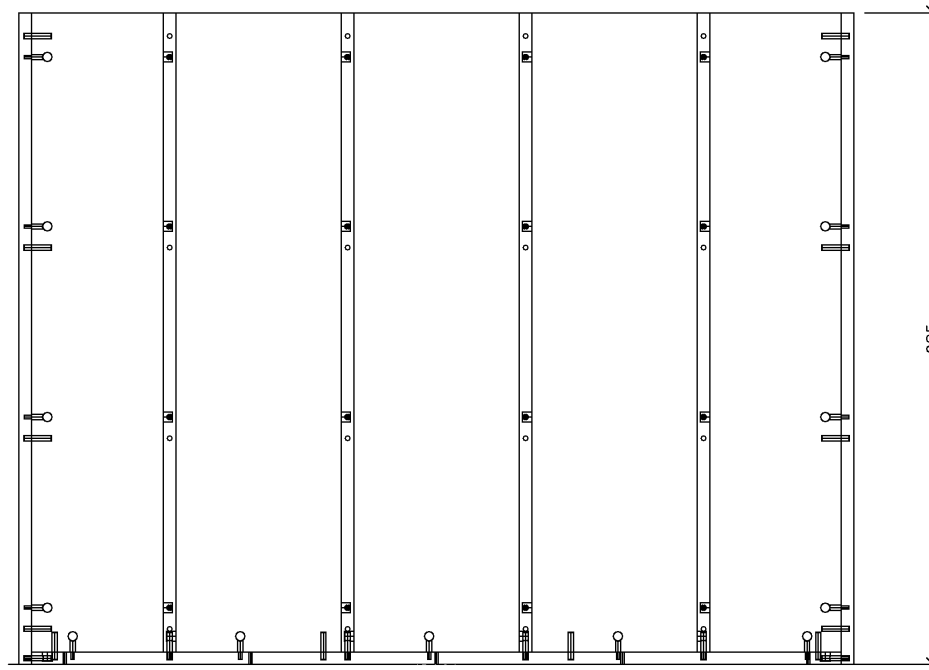

Frontansicht

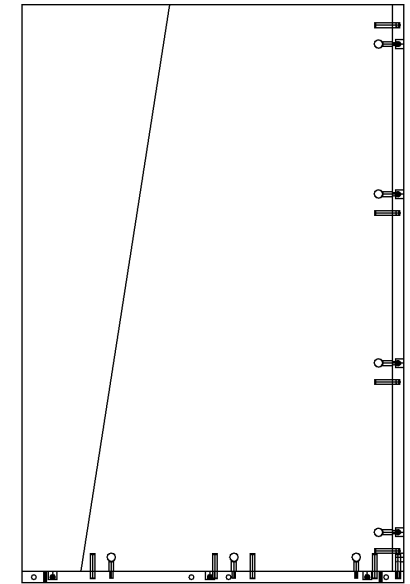

Seitenansicht rechts

1.4 Korpus oben links

Upper left module

Ordercolor 1	Address 1
Ordercolor 2	Address 2
Ordercolor 3	Address 3
Ordercolor 4	Zip
Ordercolor 5	Notice

Ordercolor 1	Address 1
Ordercolor 2	Address 2
Ordercolor 3	Address 3
Ordercolor 4	Zip
Ordercolor 5	Notice

Date	Article name
Current 3/20/2020	49176
Modified 3/19/2020	Article description
Created 2/3/2020	Construction
Loading	STANDARD
Delivery	

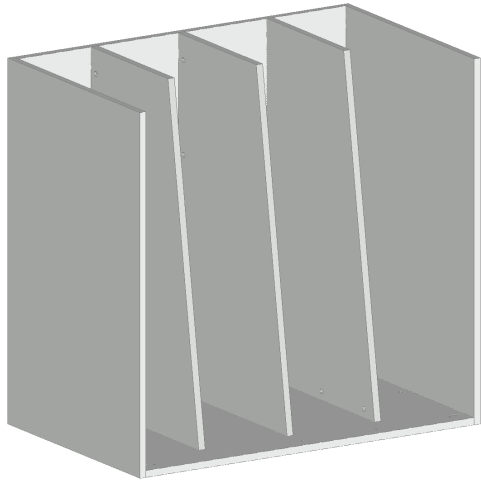

Ansicht

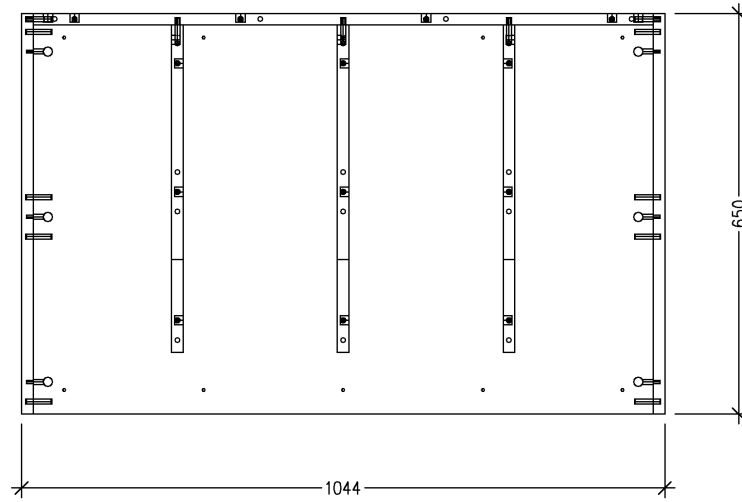

Draufsicht

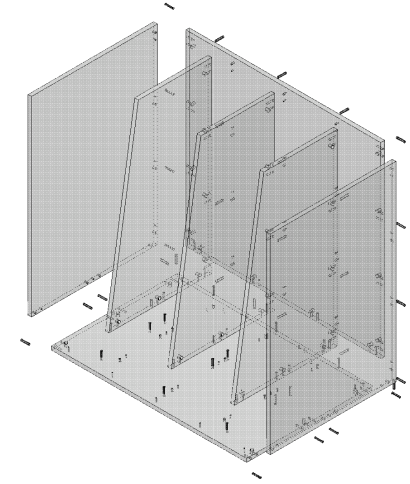

Explosionszeichnung

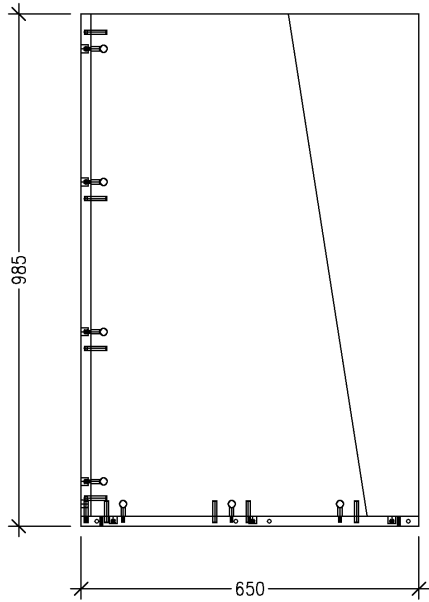

Seitenansicht links

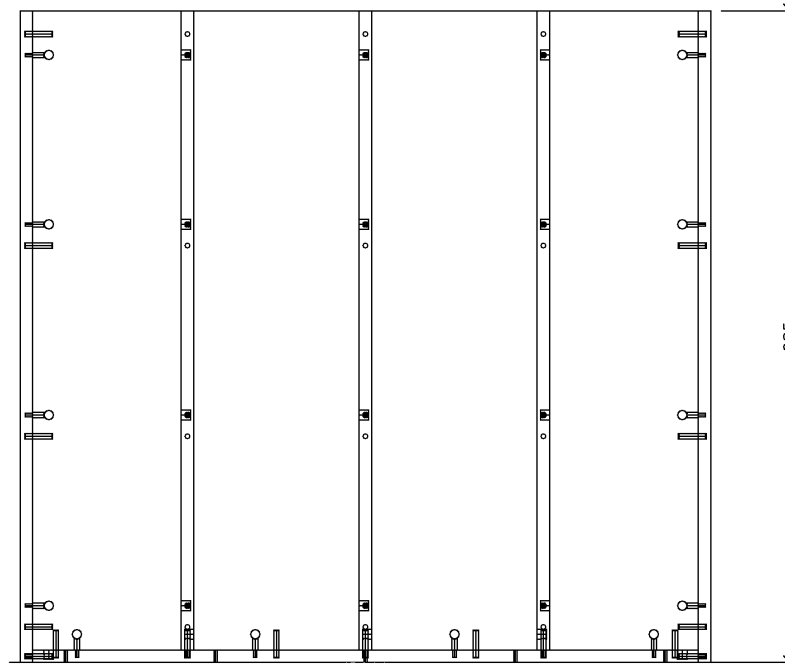

Frontansicht

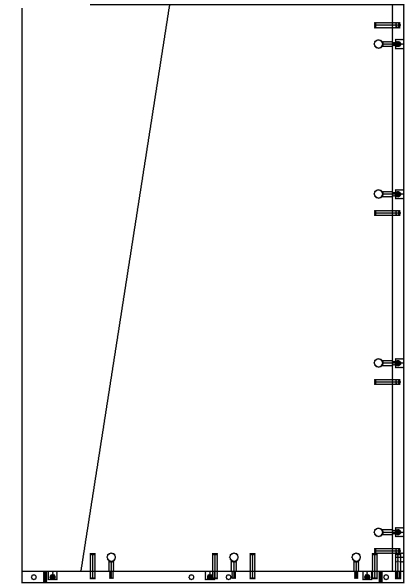

Seitenansicht rechts

1.5 Korpus oben rechts

Upper right module

Ordercolor 1
Ordercolor 2
Ordercolor 3
Ordercolor 4
Ordercolor 5

Address 1
Address 2
Address 3
Zip
Notice

Date	Article name
Current 3/20/2020	49176
Modified 3/19/2020	Article description
Created 2/3/2020	Construction
Delivery	STANDARD

**HOMAG** SortingSolutionBasic19\_2020

Page 1
Name
Scale
1:13,8
@ XC

CSW



Ansicht

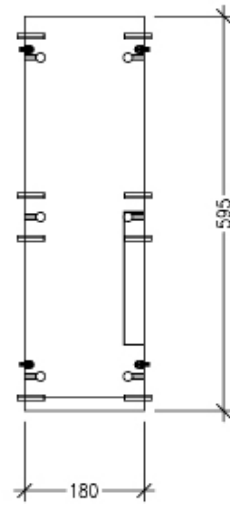

Draufsicht

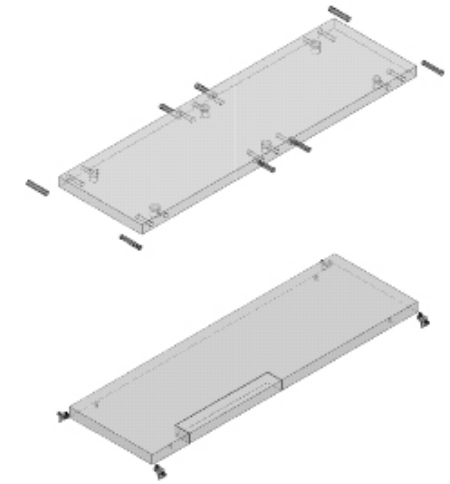

Explosionszeichnung

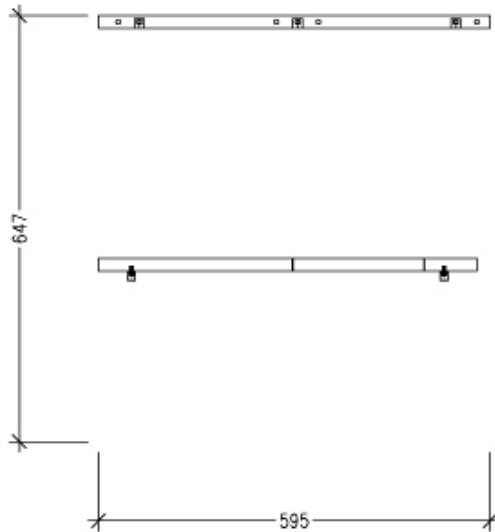

Seitenansicht links



Frontansicht

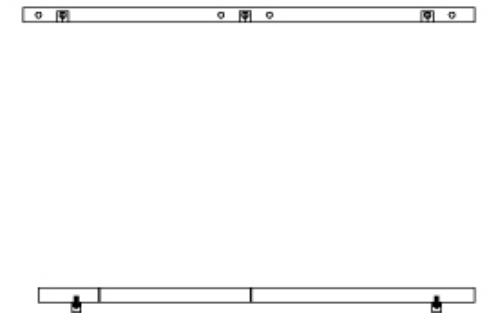

Seitenansicht rechts

1.6 Böden Korpus für Elektrobauteile

Controller Unit

Ordercolor 1	Address 1	Case	Articleno	1
Ordercolor 2	Address 2	Current	49176	1
Ordercolor 3	Address 3	Modified	Articledescription	Homag CSW
Ordercolor 4	Address 4	Created	Construction	Scale
Ordercolor 5	Address 5	Issuing	STANDARD	1:5.9
	Address 6	Delivery		2. A3
	Address 7			
	Address 8	SortingSolutionBasic19_2020		



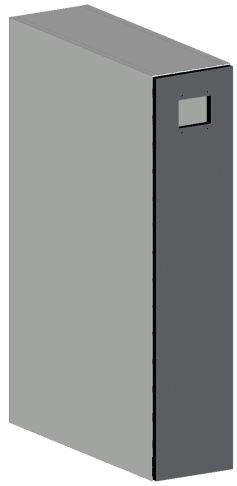

Ansicht

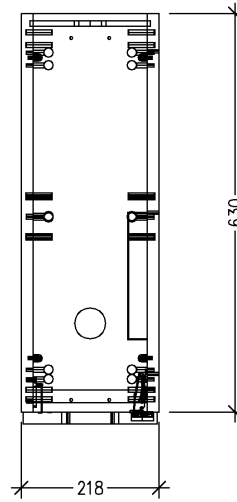

Draufsicht

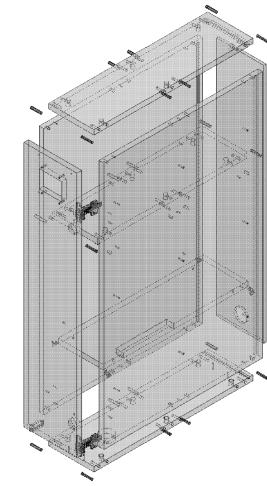

Explosionszeichnung

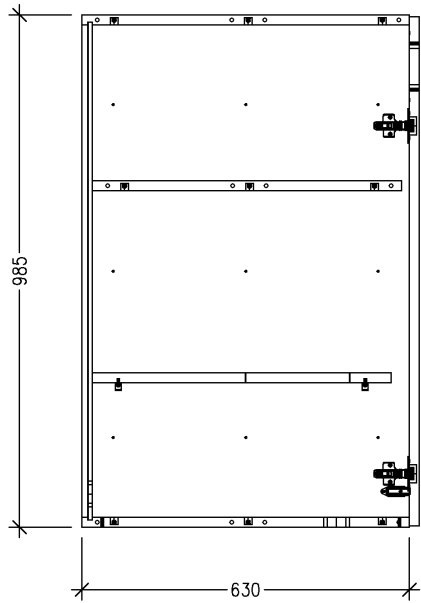

Seitenansicht links

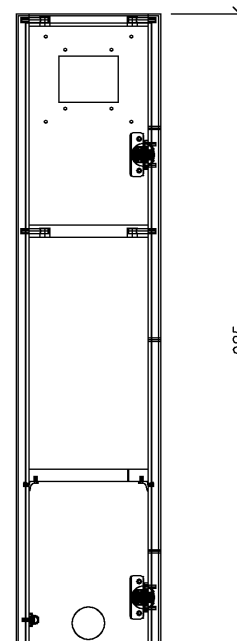

Frontansicht

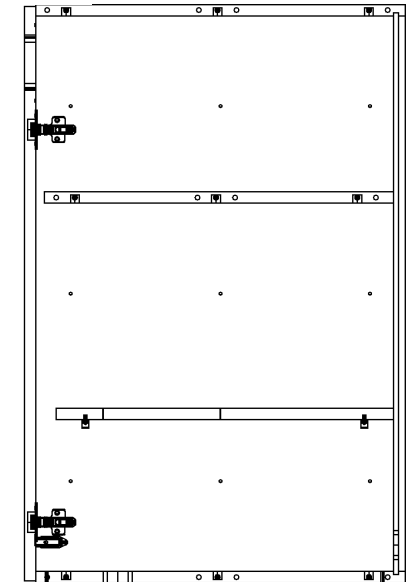

Seitenansicht rechts

1.6 Korpus für Elektrobauteile

Controller Unit

Ordercolor 1
Ordercolor 2
Ordercolor 3
Ordercolor 4
Ordercolor 5

Address 1
Address 2
Address 3
Zip
Notice

Date	Article name
Current 3/20/2020	49176
Modified 3/19/2020	Article description
Created 2/3/2020	
Loading	Construction
Delivery	STANDARD

**HOMAG** SortingSolutionBasic19\_2020

1	Page
Name	Homag CSW
Scale	1:12,4
of 4	



Ansicht

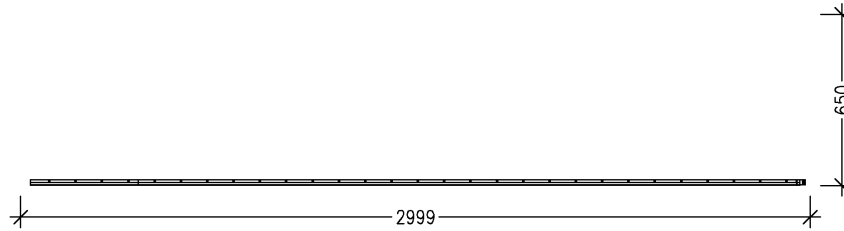

Draufsicht

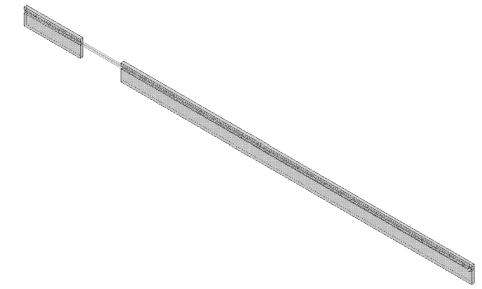

Explosionszeichnung

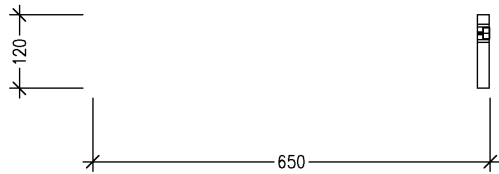

Seitenansicht links



Frontansicht

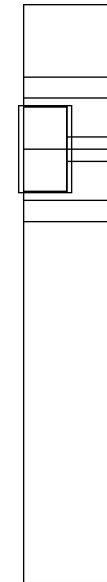

Seitenansicht rechts

2.1 Blenden untere LED-Leiste

LED Base

Ordercolor 1
Ordercolor 2
Ordercolor 3
Ordercolor 4
Ordercolor 5

Address 1
Address 2
Address 3
Zip
Notice

Date	Articlename
Current 3/20/2020	SortingSolutionBasic
Modified 3/19/2020	Articledescription
Created 2/3/2020	Construction
Loading	STANDARD
Delivery	

Page 1
Name Homag CSW
Scale 1:28
© A3



Ansicht

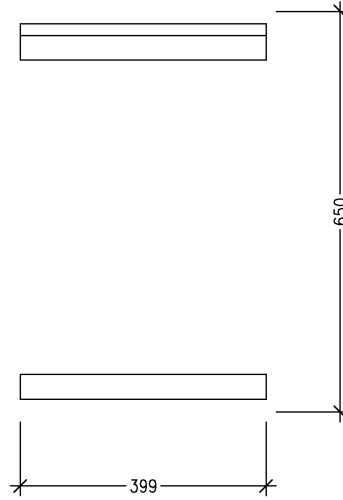

Draufsicht

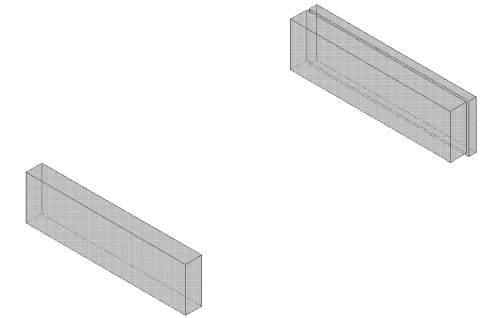

Explosionszeichnung

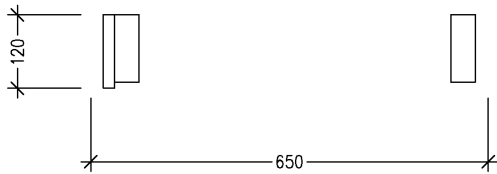

Seitenansicht links

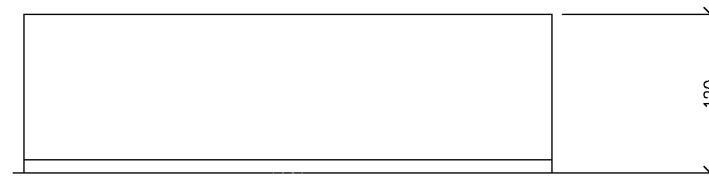

Frontansicht



Seitenansicht links

2.1 Blenden untere LED-Leiste links

Long parts base

Ordercolor 1	Address 1	Date	ArticleName	Page
Ordercolor 2	Address 2	Current 3/20/2020	49159	1
Ordercolor 3	Address 3	Modified 3/19/2020	ArticleDescription	Name
Ordercolor 4	Zip	Created 2/3/2020	Construction	Homag CSW
Ordercolor 5	Notice	Delivery	STANDARD	Scale
				1:7.4
		SortingSolutionBasic19_2020		of 3

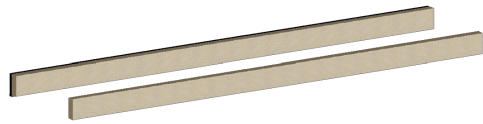

Ansicht

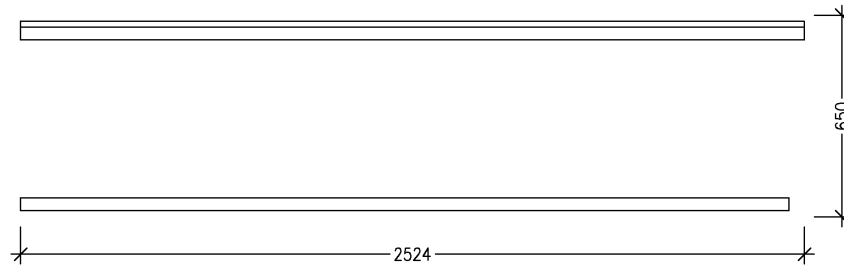

Draufsicht

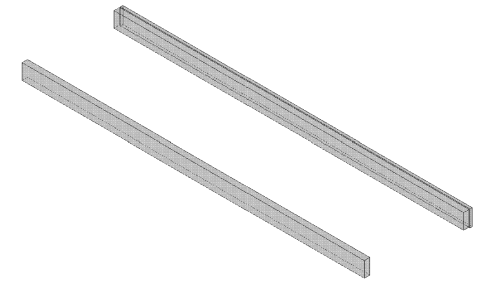

Explosionszeichnung

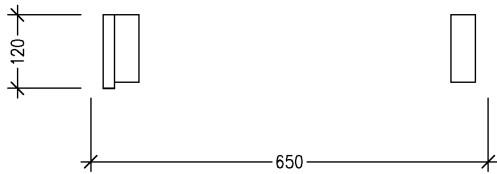

Seitenansicht links

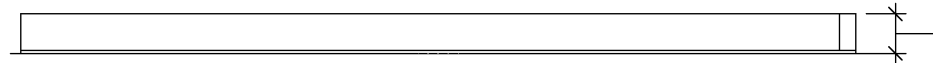

Frontansicht



Seitenansicht rechts

2.1 Blenden untere LED-Leiste Massivholz

Base right

Ordercolor 1	Ordercolor 2	Ordercolor 3	Ordercolor 4	Ordercolor 5	Address 1	Address 2	Address 3	Zip	Notice	Date	Articlename	Page
										Current	49176	1
										Modified	Article description	Name
										Created	STANDARD	Scale
										Construction	1:27,1	CSW
										SortingSolutionBasic19_2020		

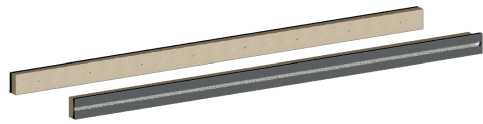

Ansicht

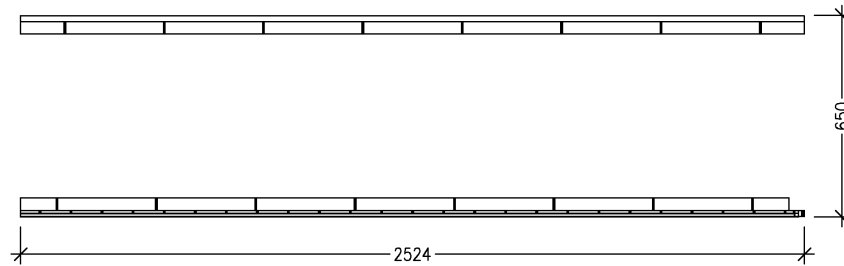

Draufsicht

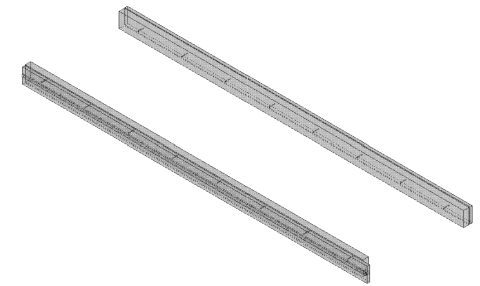

Explosionszeichnung

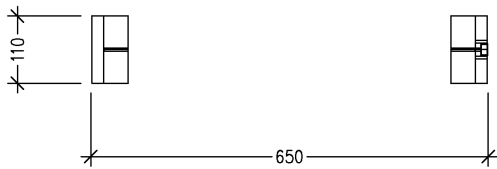

Seitenansicht links

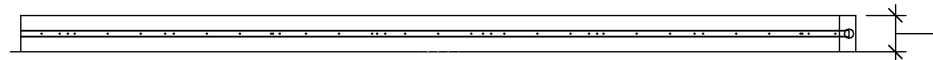

Frontansicht

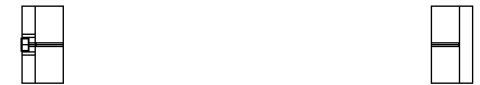

Seitenansicht links

2.2 Blenden mittlere LED-Leiste

LED Upper

Ordercolor 1
Ordercolor 2
Ordercolor 3
Ordercolor 4
Ordercolor 5

Address 1
Address 2
Address 3
Zip
Notice

Date	Articlename
Current 3/20/2020	49176
Modified 3/19/2020	Articledescription
Created 2/3/2020	
Loading	Construction
Delivery	STANDARD

Page	1
Name	Homag
Scale	1:27,8
of	XX

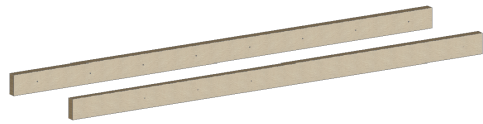

Ansicht

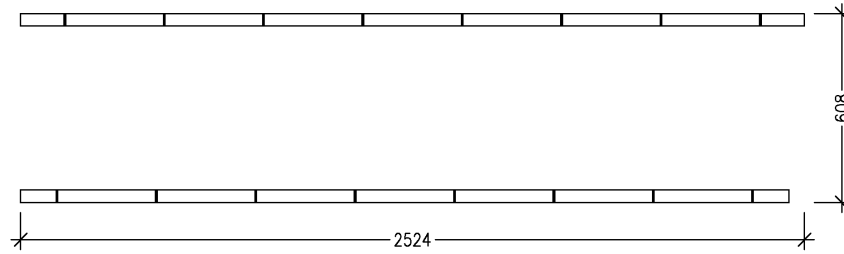

Draufsicht

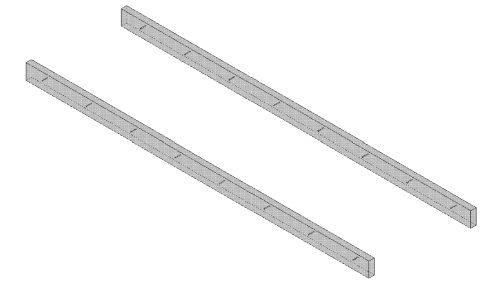

Explosionszeichnung

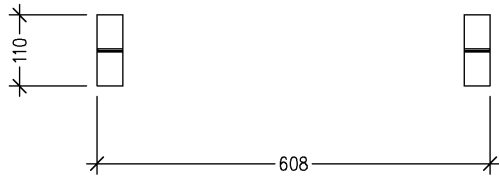

Seitenansicht links

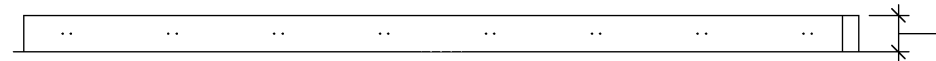

Frontansicht



Seitenansicht rechts

2.2 Blenden mittlere LED-Leiste Massivholz

Crossbar

Ordercolor 1
Ordercolor 2
Ordercolor 3
Ordercolor 4
Ordercolor 5

Address 1
Address 2
Address 3
Zip
Notice

Date	3/20/2020
Current	49176
Modified	3/19/2020
Created	2/3/2020
Loading	
Delivery	

Article name	49176
Article description	
Construction	STANDARD

Page	1
Name	Homag
Scale	1:27,1
of	7

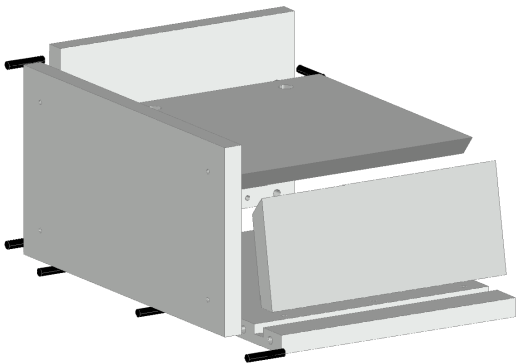

Ansicht

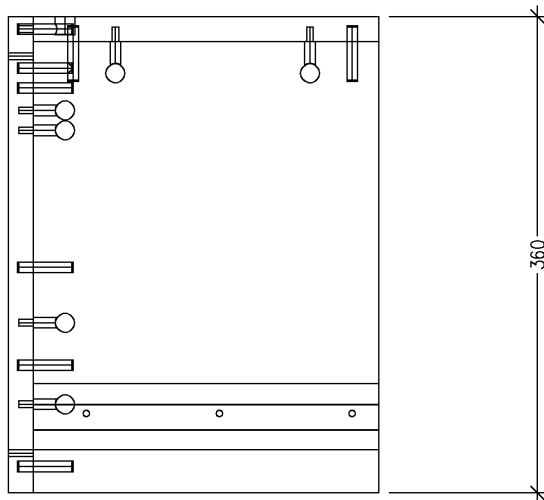

Draufsicht

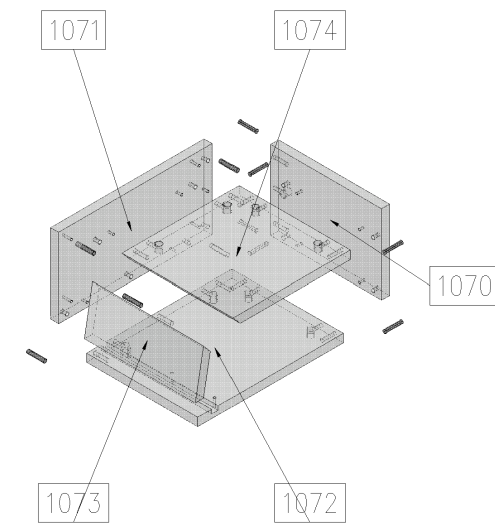

Explosionszeichnung

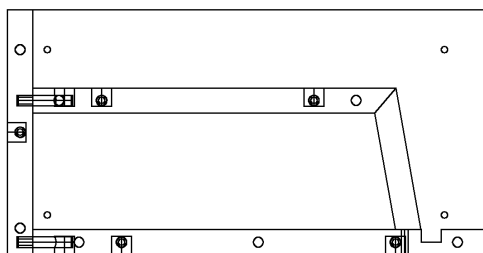

Seitenansicht links

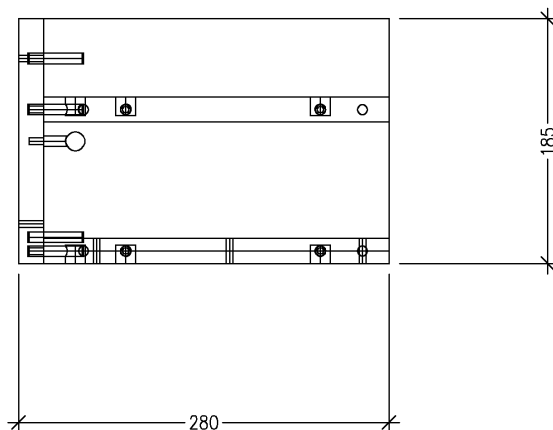

Frontansicht

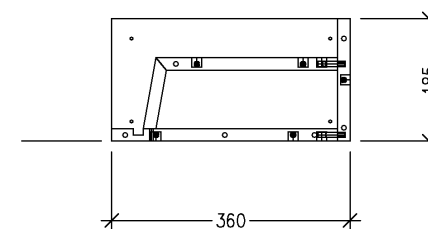

Seitenansicht rechts

### 3.1 Tablehalterung Details

Artikelinfo	Artikelinfo 1	Artikelinfo 6	Dimensionen / Weight / Position	Artikel Height	Ordercolor	Address 1	Date	Artikelname	Page							
	Artikelinfo 2	Artikelinfo 7		185				Ordercolor 1		Address 2	Current	3/20/2020	DF_Tablet_Tray_Sort	1		
	Artikelinfo 3	Artikelinfo 8		280				Ordercolor 2			Address 3	Modified	3/19/2020	Artikelbeschreibung	Name	
	Artikelinfo 4	Artikelinfo 9		360				Ordercolor 3				Zip	Created	2/3/2020	Artikel Designer Gruppe	Homag CSW
	Artikelinfo 5	Artikelinfo 10		3.949				Ordercolor 4					Notice	Loading	Construction	STANDARD
		002	Ordercolor 5		Delivery			1:5								
<p style="text-align: center;"><b>HOMAG</b> SortingSolutionBasic19_2020</p>									@ A3							